



Theia[®]

TECHNOLOGIES

TL410P R5 CS 4K Resolution Day/Night lenses up to 1/1.7" sensors

- ✓ **Ultra high resolution for 4K cameras**, up to 12.4 megapixel
- ✓ P-iris for precise aperture control
- ✓ **Fully motorized** with zoom, focus, iris, and limit switches
- ✓ Optional motor control board (MCR500) available for easy integration
- ✓ IR corrected for true **Day/Night** cameras
- ✓ **Compact design** to fit into domes as small as 4" mini-dome size
- ✓ **CS-mount**
- ✓ Used for sensor sizes 1/2.5", 1/2.3", 1/2", 1/1.8", and **up to 1/1.7"** (Sony IMX178, Sony IMX226 for example)

TL410 lens specifications

Focal length (FL)	4-10mm
Mount type	CS-mount
Iris type	P-iris
Image circle	Ø9.4mm at FL 4mm
Resolution	12.4 megapixel
F/#	F/1.4 @ 4mm – F/2.4 @ 10mm to close
Focus Range	0.5m to infinity
IR Correction	440nm – 950nm (Day/Night)
Lens length (TTL)	< 64mm TTL
Back focal length (BFL)	8.4mm (in air)
Chief ray angle (CRA)	< 7°
Geometric distortion	< 61% at 4mm, < 8% at 10mm
Relative illumination	>45%
Lens transmission	>80%
Weight	75g
Operating temperature	-20C to 60C (<70% humidity, non-condensing)
Storage temperature	-30C to 70C (<90% humidity, non-condensing)

Field of view for sensor sizes

Sensor size	1/1.7"	1/1.8"	1/1.8" 4K*	1/2"	1/2.3"	1/2.5"
Horizontal	112° - 44°	110° - 43°	110° - 43°	93° - 37°	90° - 36°	83° - 33°
Vertical	81° - 33°	71° - 29°	52° - 21°	68° - 28°	67° - 27°	60° - 25°
Diagonal	149° - 55°	139° - 52°	126° - 48°	120° - 46°	117° - 45°	106° - 42°

*4K format = 4000 x 2000 pixels



Visit Theia's website for more information about the lenses.

Lens drawing

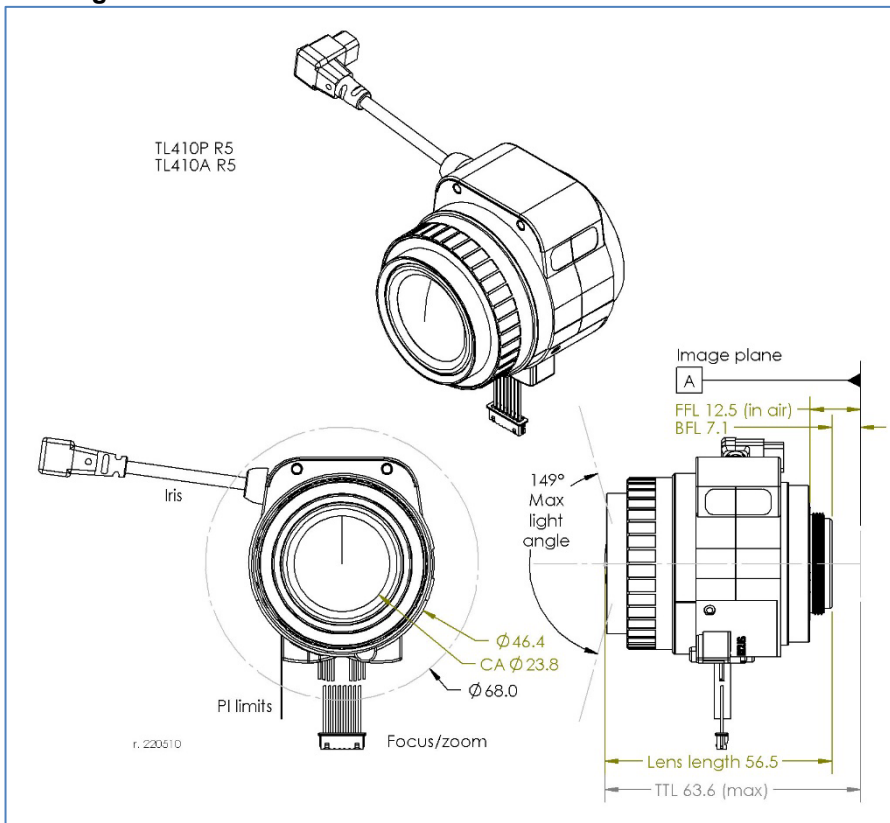

CAD models can be downloaded from
TheiaTech.com/410CAD

Entrance pupil location

The entrance pupil location is inside the lens. The first lens element vertex or the lens plastic can be used as a reference to find the location.

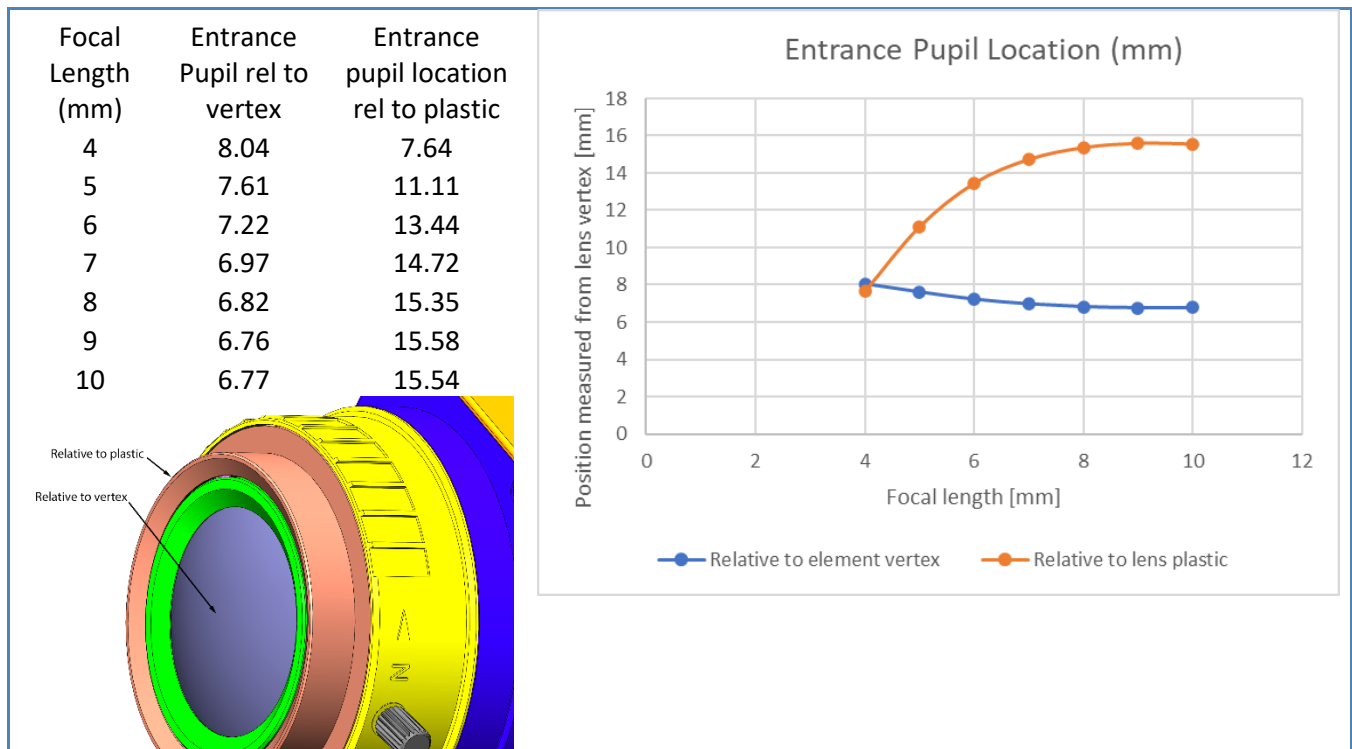

Zoom/Focus motor specifications

Drive	Stepper motor 2 phase bipolar drive
Operation voltage	3.3V (range 2.6~4.8V)
Maximum motor temperature*	Do not let motor temperature exceed 92°C
Coil resistance	28.5Ω (±7%)
Zoom number of steps	4073 steps between hard stops
Zoom speed range	600pps to 1000pps
Zoom cam rotation	85°
Focus number of steps	9354 steps between hard stops
Focus speed range	600pps to 1000pps
Focus cam rotation	196°
Focus/zoom connectors	Housing: Molex 51021-0800 Terminal: Molex 50058-8000
Cable length	150mm

Zoom: Wide -> Tele				
Focus: Near -> ∞				
Step	A+	A-	B+	B-
0	H	L	H	L
1	L	H	H	L
2	L	H	L	H
3	H	L	L	H

Pin	Color	Function	Motor
1	Brown	A+	Focus
2	Red	A-	Focus
3	Yellow	B+	Focus
4	Gray/Orange	B-	Focus
5	Brown	A+	Zoom
6	Red	A-	Zoom
7	Gray/Orange	B+	Zoom
8	Yellow	B-	Zoom

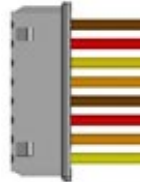

*Theia's motor temperature calculator can be used to estimate the focus and zoom motor temperatures after a set number of run/ cool down cycles. This can be downloaded from Theia's website (see the QR code below).

The example below shows 60C ambient temperature and 3.5V motor. The motor is driven for 10 seconds with 10 seconds cool down between moves. After 3 moves, the motor is allowed to cool down which takes about 4 minutes.

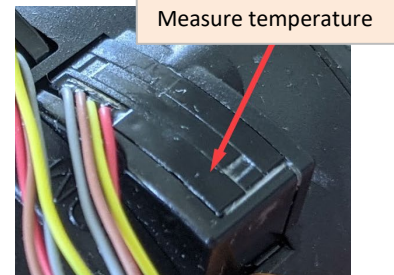
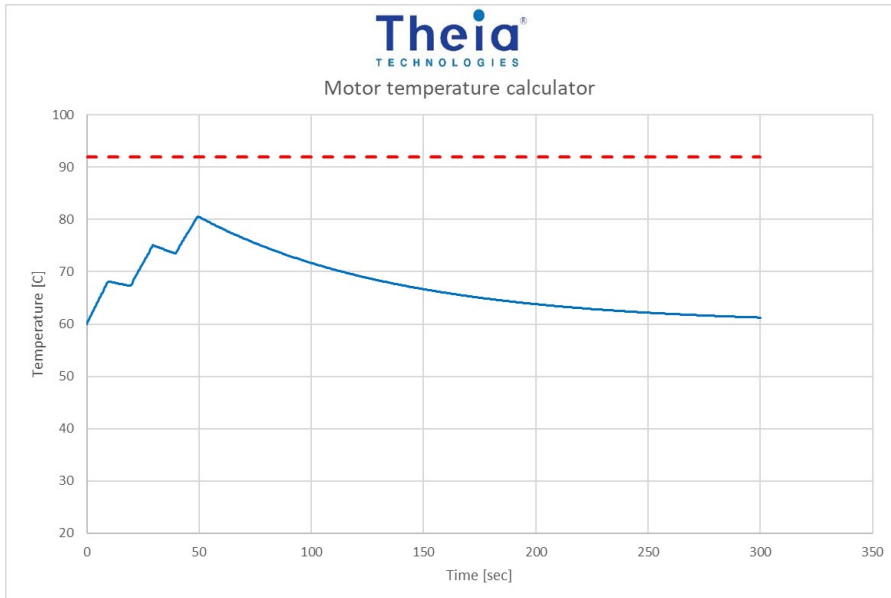

Motor temperature calculator
TheiaTech.com/calculators

Zoom and focus **motor positions may be affected by backlash and lost steps during movement. Lost steps are affected by the driving conditions. It is best to drive the motor between 600pps and 1000pps with 4-12 steps of acceleration/deceleration. Acceleration is especially helpful at higher driving speeds. Within these limits, the lost steps are tested to be <40 steps per full zoom range and <30 steps per full focus range.

Zoom/Focus motor step map (at infinite focus position). PI positions only available with -R5 and -R6 lenses.

Zoom motor		Focus motor	
<i>Note</i>	<i>Step</i>	<i>Note</i>	<i>Step</i>
Hard stop (wide)	4073	Hard stop (far)	9353
Wide design position	4073	PI position	8652
PI position	154		
Tele design position	0		
Hard stop (tele)	0	Hard stop (near)	0

Zoom/Focus synchronizing map (observe min/max motor speeds)

Focal length	Zoom motor note	Zoom motor step number	Focus ring note	Focus motor step number
<i>[mm]</i>		<i>[#]</i>		<i>[#]</i>
4.15	Wide end	4073		288
4.96		3501		3149
5.77		2929		4892
6.58		2356		6125
7.39		1784		7687
8.19		1212		8599
9.00		640		8960
9.70		139		8931
9.90	Tele end	0		8871

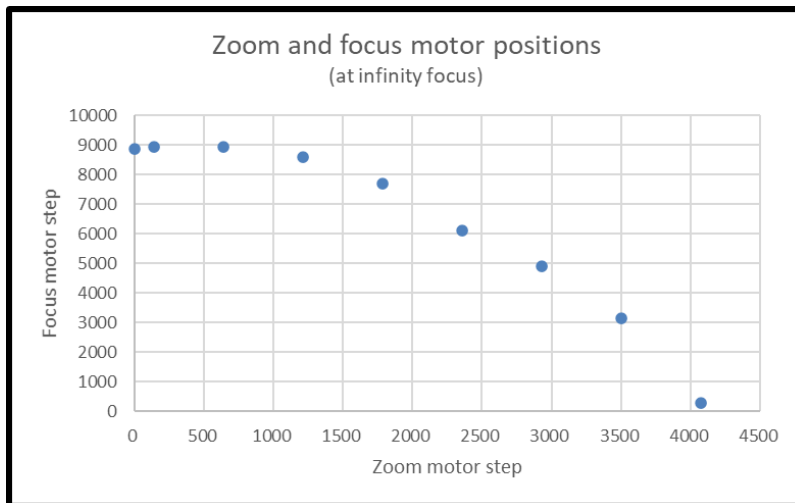

Notes:

These motorized lenses are intended for integration into cameras and require motor drivers and controllers. Typically, Theia works with the camera manufacturer to ensure that the camera motor controller matches the lens. It is possible to supply your own motor controller, but Theia cannot guarantee that your motor controller will not damage the lens. Theia does not offer any warranty on the suitability of these motorized lenses for any particular camera. These motorized lenses are **not intended for continuous use** of the motors as in PTZ applications. Theia offers motor control boards that are suitable to control motorized lenses with P-iris.

P-iris motor specifications

Drive	Stepper motor 2 phase bipolar drive
Operating voltage	4V (+/-1)
Number of steps	75
Basic step angle	18°
Maximum response freq.	200 pps
Coil resistance	30Ω (each phase)

P-iris: open->close				
Step	A+	A-	B+	B-
0	H	L	H	L
1	L	H	H	L
2	L	H	L	H
3	H	L	L	H

Connector type 2 (CCTV)

Connector type	Housing: EYC 221
Cable length	300mm

Pin	Function
1	B+
2	A+
3	A-
4	B-

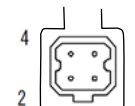

P-iris motor map

Step	Aperture Size [mm2]	F/#
1	65.0	1.43 (open)
5	65.0	1.43 (open)
10	65.0	1.43 (open)
15	65.0	1.43 (open)
19	65.0	1.43 (open)
20	63.4	1.50
25	54.0	1.63
30	44.9	1.78
35	36.0	1.98

Step	Aperture Size [mm2]	F/#
40	27.7	2.26
45	20.0	2.65
50	13.2	3.26
55	7.5	4.34
60	3.1	6.71
65	0.8	12.86
70	0.1	46.06
72	0.0	Closed
75	0.0	Closed

Zoom/Focus limit switch

Type	Photo interrupter phototransistor
Part model	Sharp GP1S396HCPSF
Operating voltage	3.3V
Output level	>2.2V HIGH <0.6V LOW
Connector type	FPC cable
Board-side mating connector type (not supplied)	Molex 52746-0671 Molex 52745-0697 Molex 52559-0652
Cable length	150mm

Pin*	Function	Motor
1	Emitter	Focus
2	Anode/Collector	Focus
3	Cathode	Focus
4	Emitter	Zoom
5	Anode/Collector	Zoom
6	Cathode	Zoom



*cable side pin designation matches Molex 52746-0671 bottom side contacts connector
Recommended circuit for each photo interrupter

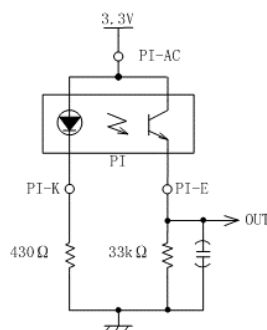

Alternate lens options

There are other options for motor configurations, iris types, and mount types. Please visit www.theiatech.com to learn more about our other lens options and to download the datasheets for other lenses.

<i>Theia</i> ® PN	Varifocal	LOT® technology	Mount type	Mount slip ring	Iris type	CCTV iris con.	Molex iris con.	IR corrected (day/night)	IR cut switch	Zoom motor	Focus motor	PI limits	Focal length	MP rating	f/#	Image circle	Biggest sensor format	MOD [m]	Lens Length (to mount)	Lens Length (TTL)	Weight [g]
TL410A R6	✓		CS	✓	A		✓	✓	✓	✓	✓	PI	4-10	12 (4K)	f/1.4	9.4	1/1.7"	0.5	51.5	64	78
TL410A R5	✓		CS	✓	A	✓		✓		✓	✓	PI									80
TL410A R4	✓		CS	✓	A		✓	✓	✓	✓											77
TL410P R6	✓		CS	✓	P		✓	✓	✓	✓	✓	PI									75
TL410P R6 25	✓		D25		P		✓	✓	✓	✓	✓	PI									78
TL410P R5	✓		CS	✓	P	✓		✓		✓	✓	PI									77
TL410P R4	✓		CS	✓	P		✓	✓	✓	✓	✓										74
TL410P R3	✓		CS	✓	P	✓		✓		✓	✓										76
Related versions without motorized zoom and focus																					
SL410M	✓		CS	✓	M		✓						4-10	12 (4K)	f/1.4	9.4	1/1.7"	0.5	51.5	64	72
SL410P	✓		CS	✓	P	✓	✓														75
SL410A	✓		CS	✓	A	✓	✓														78
ML410M	✓		CS	✓	M		✓						6-10	f/1.6	11.0	2/3"		46.5	64	67	
ML610P	✓		C	✓	P		✓													74	
ML610M	✓		C	✓	M		✓													70	

For more information contact
Theia Technologies

info@TheiaTech.com
www.TheiaTech.com
+1-503-570-3296

Revisions

Version	Change	Reason
220401	Templated spec sheet	Family spec sheet can be reduced for each lens model to simplify spec sheet
220516	Alternate lens table	Updated to separate non-motorized versions
220920	Formatting error in focus/zoom motor table	Row data and headers were on different rows
	Remove near focus/far focus positions	Not relevant to customers, removed for clarity
240130	Updated Zoom/Focus Motor Map	Error in step count